

INPHENIX

SLD Light Source Module

Part Number: IPSDS1504-xxxx

1. Configuration

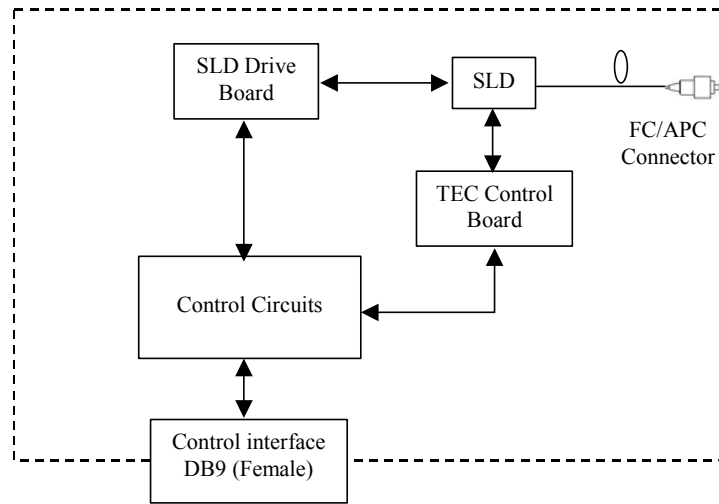

Figure 1 Configuration of IPSDS1504-xxxx SLD light source module

2. Absolute Maximum Ratings

Parameter	Min.	Max.	Unit
Power Supply Voltage	4.5	5.5	V
Storage Temperature	-40	+85	°C
Humidity	10	95	%

3. Recommended Operational Condition

Parameter	Min.	Typ.	Max.	Unit
Power Supply Voltage	4.75	5.00	5.25	V
Ripple/spike noise of Power Supply Voltage	-	50	120	mV _{p-p}
Operating Temperature	15	25	50	°C
Operating Humidity	30	60	90	%

INPHENIX

4. Optical characteristics

Items	Specifications			Unit	Notes
	Min.	Typ.	Max.		
Center Wavelength @ -3dB	1535	1550	1575	nm	@ 25°C and CW. Connectors are included.
3dB Optical Bandwidth	55	60	-	nm	
Optical Output Power	8	10	-	mW	
ASE Ripple @ 0.1nm	-	0.2	0.5	dB	
Optical Power Stability (8hr)	-	-	±0.1	dB	Stability test of P _{max} after 0.5 hour warm up at 25°C
Optical Output Type	FC adaptor or pigtail fiber out			-	As shown in Figure 2 of Section 7 in detail
Fiber Connector	FC or SC type			-	
Fiber Type	Corning SM-28 or equivalent			-	
Fiber Jacket	900µm loose tube			-	
Fiber Length	0.5	-	-	m	If pigtail fiber out is selected.

5. Electrical characteristics

Item	Specifications			Units	Notes
	Min.	Typ.	Max.		
Power supply current	-	1.0	2.0	A	Pmax CW optical output
Power consumption	-	5.0	10.0	W	
Range of V _{SET}	0.0	-	2.5	V	
Input impedance for V _{SET}	> 20k			Ω	
VH for TTL input/output	3.80	-	-	V	For SLD Enable and Alarm
VL for TTL input/output	-	-	1.02	V	
Optical Power Control	SLD Current Adjustment via V _{SET} as shown in Section 6 in detail			-	
Connector Type	DB9 Connector, Female			-	See section 6 for Pin Allocation in detail

INPHENIX

6. Pin Assignment Specifications

DB9 Connector Pin Allocation

Pin #	Function	In/Out	Type	Description
1	+5VDC	IN	Analog (5.0V)	Power Supply, $\leq 2A$.
2	NC	NA	NA	Reserved
3	SLD Enable	IN	TTL	SLD turn on control. TTL high turns on SLD and TTL low turns off SLD. See Figure 3 in detail.
4	Alarm	OUT	TTL	TEC operation status. TTL high indicates that TEC failure has activated and TTL low indicates that TEC operation is normal. See Figure 3 in detail.
5	V _{SET}	IN	Analog (0~2.5V)	Input voltage to set SLD current. The range of 0.0-2.5V for V _{SET} corresponds to 0~I _{max} mA of SLD operation current.
6	GND	IN	GND	Power supply and signals GND.
7	NC	NA	NA	Reserved
8	NC	NA	NA	Reserved
9	NC	NA	NA	Reserved

INPHENIX

7. Mechanical Specifications

66. Drawing and dimensions (unit: mm): 100mm(L)×80mm(W)×26mm(H)

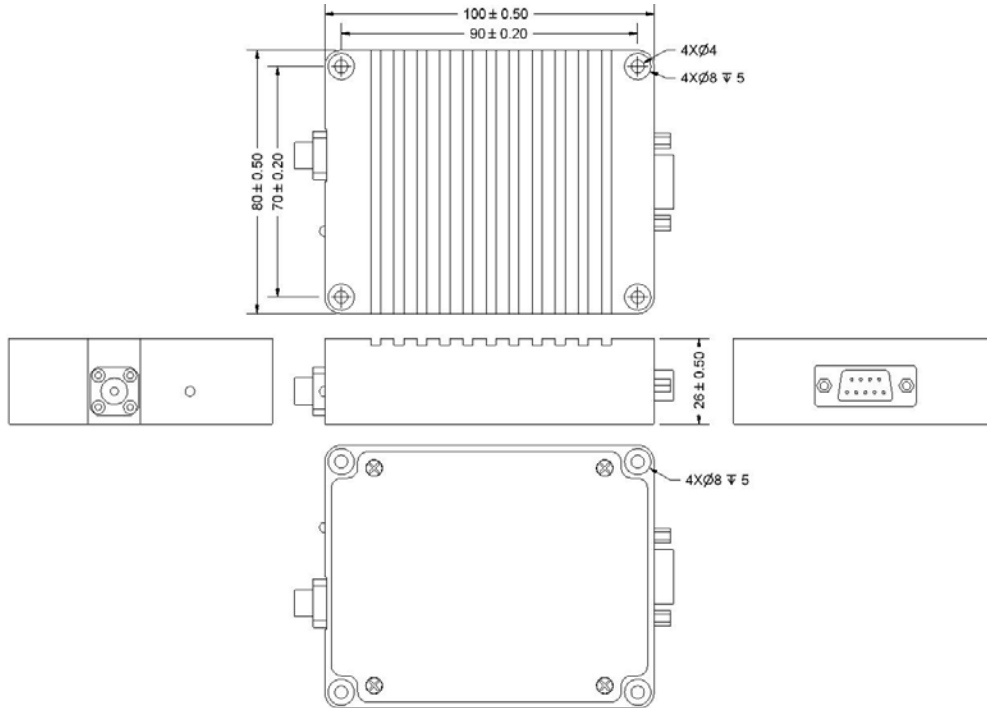

Figure 2 Mechanical drawing of module box (FC/APC connector with FC adaptor)

2. Module case is isolated from any electrical connection.

8. Signals Characteristics

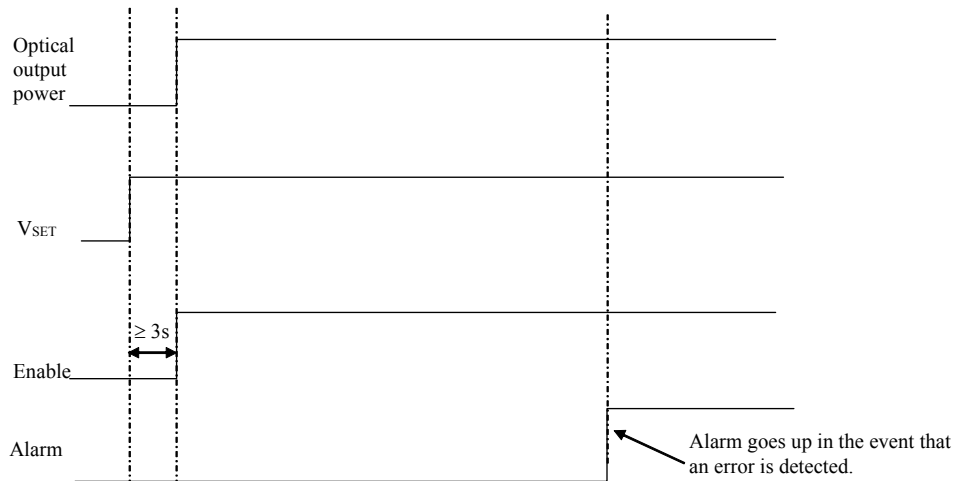

Figure 3 Startup and operational timing of the module

INPHENIX

9. Part Numbering Structure of SLD light source module



Model Number

- 07**: 700~790nm SLD
- 08**: 800~890nm SLD
- 09**: 900~990nm SLD
- 10**: 1010~1090nm SLD
- 13**: 1300~1390nm SLD
- 14**: 1400~1490nm SLD
- 15**: 1500~1590nm SLD

Output Type

- 0: FC Adaptor
- 1: Pigtail fiber

Connector Type

- 0: No Connectors
- 3: FC/APC 4: FC/UPC
- 7: SC/APC 8: SC/UPC

Fiber Type

- 1: 900µm SM Fiber
- 2: 900µm PM Fiber

Case Size

- 1: 100×80×26mm case
- 2: 130×100×26mm case
- 3: 130×115×36mm case

Example: IPSDS0701-1011: 700nm-type SLD light source module in 100×80×26mm case with pigtail fiber output, 900µm SM fiber without connector

Corporate Office
 250 North Mines Rd
 Livermore, CA 94551
 Tel: 925.606.8809
 Fax: 925.606.8810
www.inphenix.com
sales@inphenix.com